

Romolo RM4.3 1433x500

Height: 1433
Width: 500
Depth: 115
Weight HO: kg
EO: kg

Tube ϕ : 25.4 + 22
Pipe Centres / Face-Face Cons: 450
Elec. element if specified: n/a
Output @ 50° C Δ T Watts: 263 W
BTUs: W

All dimensions in millimetres

Manufactured from ISO/CEN CuZn30As (BS CZ126) brass tube

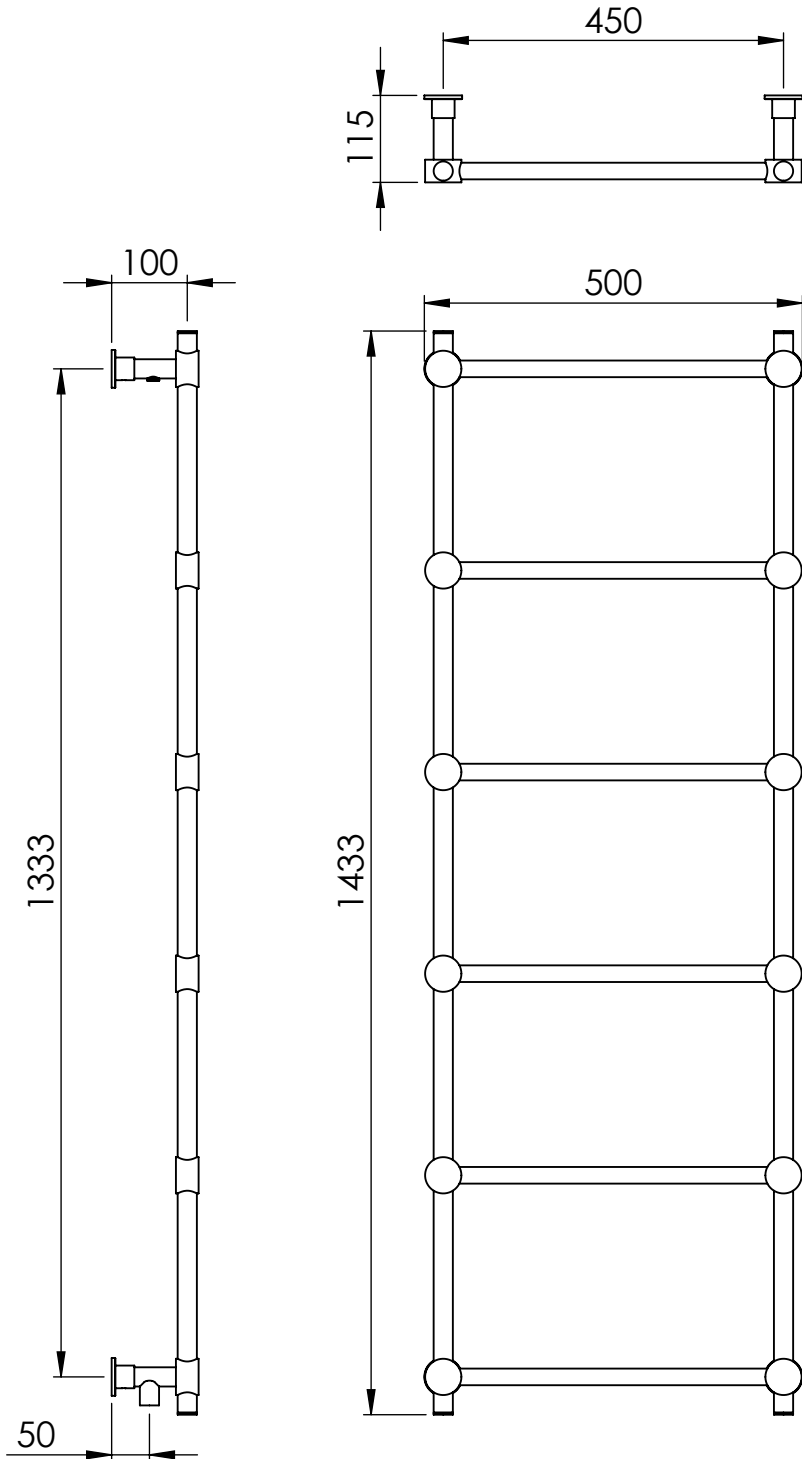
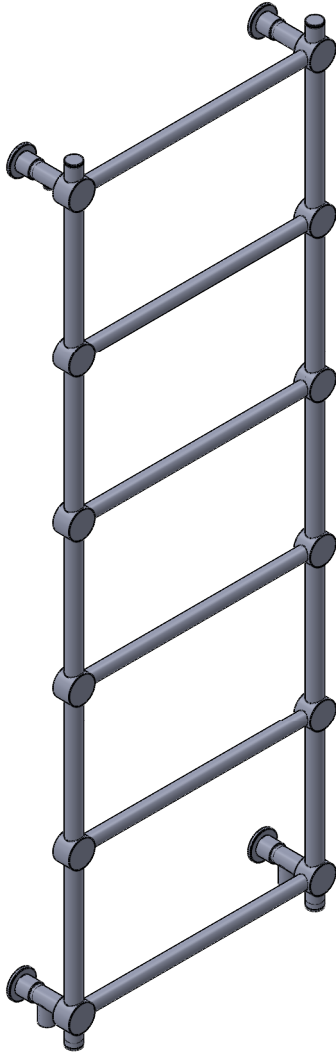

Vogue UK Ltd. reserve the right to alter specifications without prior notice.
ALL MEASUREMENTS ARE NOMINAL DIMENSIONS ONLY, AND ARE NOT BINDING.

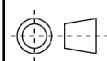

SCALE 1:10

VOGUE
TOWEL WARMERS & RADIATORS

Strawberry Lane, Willenhall
West Midlands WV13 3RS
Tel: 01902 387000 Fax: 01902 387001
e-mail:sales@vogueuk.co.uk www.vogueuk.co.uk